

PRO-122T | INDUSTRIELE TAP EN BOORMACHINE



De PRO-122T machine is ontworpen voor industriële boor en tap toepassingen.

Krachtige motor met variabel toerental maakt kernboren tot 120 mm en spiraalboren tot 31,75 mm mogelijk.

De vooruit- en achteruitwerk modi van de machine maken draadsnijden tot M30 mogelijk met het nieuwe tap systeem van Promotech.

Versnellingsbak met vier versnellingen en traploze snelheidsaanpassing maakt het mogelijk om de optimale snelheid in te stellen afhankelijk van diameter, staalkwaliteit of gereedschapskwaliteit.











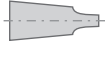

Intelligent snelheidsregelsysteem zorgt voor een constant toerental, ongeacht veranderende belastingen van de motor.

Innovatieve 360 graden LED-indicator zorgt voor een goede werking van de machine en verhoogt de werkveiligheid.

Kenmerken en voordelen:

- de meest krachtige motor in zijn klasse (onder MK3-boren) met heavy duty 4-speed versnellingsbak
- intelligent snelheidsregelsysteem verzorgt een stabiele snelheid ongeacht veranderingen in de belasting
- tappen van doorlopende en blinde gaten
- frezen met TCT- of HSS-frezen of boren
- elektronische koppeling
- strak stabiel ontwerp voor lange levensduur
- de tilt sensor stopt de motor in het geval van een defecte machine
- 360 graden visueel bewakingssysteem geeft de huidige toestand van de boor aan en geeft veiligheids- en diagnostische informatie, bijv. versleten koolborstels
- innovatieve slimme magneet lichter in gewicht
- intuïtief bedieningspaneel bovenop de boormachine
- grote koelvliefstofcontainer



												
Kernboor max 120 mm (4-3/4")	Spiraalboor max 31.75 mm (1-1/4")	Spindel MK3	Snij diepte 100mm (4")	Slag 225 mm (9")	Snelheid 75-110 rpm 135-200 rpm 220-320 rpm 390-570 rpm	Vermogen 2300 W	Gewicht 25 kg (55 lbs)	Schroefdraad snijden M30 (1-1/4")	Versleten koolborstels indicator	Thermisch beveiliging / oververhitting	Bescherming tegen overbelasting	Magneet onthechting beveiliging

360-graden Visueel Monitoring Systeem - VMS



 CONDITIE VAN DE BOOR		klaar om te werken (groen Led licht)
		normaal werken (wit Led licht)
		oververhitting (rood Led licht)
		noodstop / overbelasting (blauw Led licht)
		noodstop / als gevolg van trillen van de machine of een zwak oppervlak (violet Led licht)
 VEILIGHEIDS INFORMATIE		lage magnetisch kracht (groen Led licht knippert)
		bijna overbelasting (blauw Led licht knippert)
 DIAGNOSTISCHE INFORMATIE		noodstop / spanningsverlies (rood wordt blauw)
		noodstop / versleten borstels (rood wordt groen)



Kernboor tot 120 mm (4-3/4")



Spiraalboor max 31.75 mm (1-1/4")
Maximale slag 225 mm (9")



Linksom draaien (CCW counter clockwise) rotatie.
Gebruiksvriendelijke bediening voor het terugdraaien taggereedschap

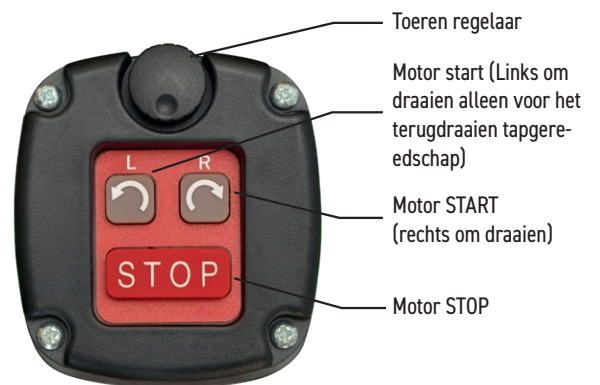

Intuïtief bedieningspaneel bovenop de boormachine

■ Promotech introduceert een snel wissel tap systeem, waaronder:

PRO-122T - Beschikbare tapconfiguraties



- TC - Tap kop met borgmoer
- TA - Tapadapters voor doorlopende gaten
- TASC - Tap Adapters met veiligheidskoppeling voor blinde gaten
- RA - Reductie Adapters

Tap gereedschap	Tapkop		
	MT3-19	MT3-31	MT3-48
M8	TA-1 of TASC-1	TA-1 of TASC-1 samen met optionele RA 2/1	TA-1 of TASC-1 samen met optionele RA 3/1
M10			
M12			
M8	TA-2 of TASC-2		TA-2 of TASC-2 samen met optionele RA 3/2
M10			
M12			
M14			
M16			
M18			
M20			
M14	TA-3 of TASC-3		
M16			
M18			
M20			
M22, M24			
M27			
M30			

Standaard tap configuratie

Optionele tap configuratie

■ Promotech snel wissel systeem accessoires geschikt voor PRO-122T boormachine:

TC - Tapkoppen met borgmoeren

Product Code	Type	Omschrijving
OPR-0584-11-00-00-1	MT3-19	Tapkop MT3 x 19 mm
OPR-0584-08-00-00-1	MT3-31	Tapkop MT3 x 31 mm
OPR-0584-02-00-00-1	MT3-48	Tapkop MT3 x 48 mm



De tapkop met borgmoer beschermt het tapgereedschap tegen uittrekken



Standaardset tapkop incl. HD-CUT OLIE 1

■ Doorlopende gaten tappen tot M30



Tapkop TC

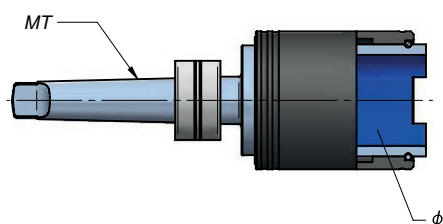

Tap Adapter TA

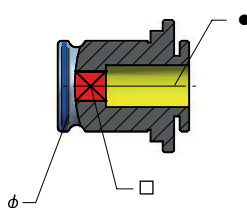

Tap gereedschap

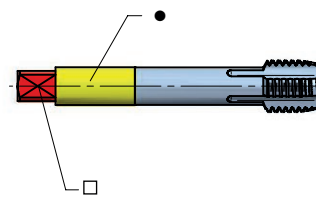

TA- Tap Adapters

Product Code	Type	Omschrijving	∅ [mm]	Tap afmeting	● [mm]	□ [mm]
WKL-000069	TA-1	Tap Adapter 19 mm x M8	19	M8	8	6,2
WKL-000070	TA-1	Tap Adapter 19 mm x M10	19	M10	10	8
WKL-000071	TA-1	Tap Adapter 19 mm x M12	19	M12	9	7
WKL-000072	TA-2	Tap Adapter 31 mm x M8	31	M8	8	6.2
WKL-000073	TA-2	Tap Adapter 31 mm x M10	31	M10	10	8
WKL-000074	TA-2	Tap Adapter 31 mm x M12	31	M12	9	7
WKL-000075	TA-2	Tap Adapter 31 mm x M14	31	M14	11	9
WKL-000076	TA-2	Tap Adapter 31 mm x M16	31	M16	12	9
WKL-000077	TA-2	Tap Adapter 31 mm x M18	31	M18	14	11
WKL-000078	TA-2	Tap Adapter 31 mm x M20	31	M20	16	12
WKL-000079	TA-3	Tap Adapter 48 mm x M14	48	M14	11	9
WKL-000080	TA-3	Tap Adapter 48 mm x M16	48	M16	12	9
WKL-000081	TA-3	Tap Adapter 48 mm x M18	48	M18	14	11
WKL-000082	TA-3	Tap Adapter 48 mm x M20	48	M20	16	12
WKL-000083	TA-3	Tap Adapter 48 mm x M22/M24	48	M22, M24	18	14.5
WKL-000084	TA-3	Tap Adapter 48 mm x M27	48	M27	20	16
WKL-000085	TA-3	Tap Adapter 48 mm x M30	48	M30	22	18

■ Blinde gaten tot M30

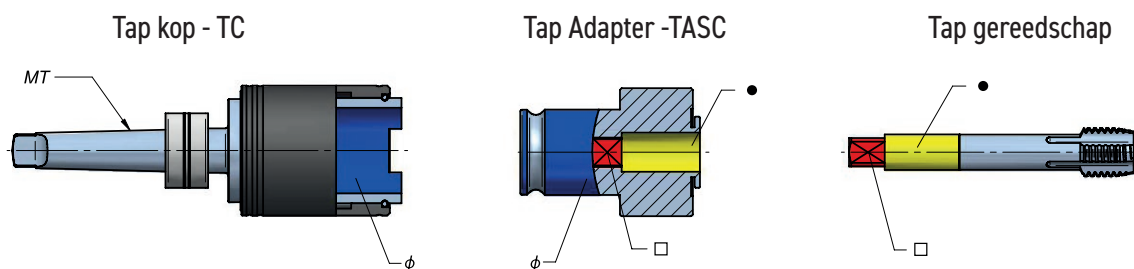

TASC – Tap Adapter met Veiligheidskoppeling

Product Code	Type	Omschrijving	ϕ [mm]	Tap afmeting	\bullet [mm]	\square [mm]
WKL-000095	TASC-1	Tap Adapter met veiligheids koppeling 19 mm x M8	19	M8	8	6,2
WKL-000098	TASC-1	Tap Adapter met veiligheids koppeling 19 mm x M10	19	M10	10	8
WKL-000099	TASC-1	Tap Adapter met veiligheids koppeling 19 mm x M12	19	M12	9	7
WKL-000100	TASC-2	Tap Adapter met veiligheids koppeling 31 mm x M8	31	M8	8	6.2
WKL-000101	TASC-2	Tap Adapter met veiligheids koppeling 31 mm x M10	31	M10	10	8
WKL-000102	TASC-2	Tap Adapter met veiligheids koppeling 31 mm x M12	31	M12	9	7
WKL-000103	TASC-2	Tap Adapter met veiligheids koppeling 31 mm x M14	31	M14	11	9
WKL-000104	TASC-2	Tap Adapter met veiligheids koppeling 31 mm x M16	31	M16	12	9
WKL-000105	TASC-2	Tap Adapter met veiligheids koppeling 31 mm x M18	31	M18	14	11
WKL-000106	TASC-2	Tap Adapter met veiligheids koppeling 31 mm x M20	31	M20	16	12
WKL-000107	TASC-3	Tap Adapter met veiligheids koppeling 48 mm x M14	48	M14	11	9
WKL-000108	TASC-3	Tap Adapter met veiligheids koppeling 48 mm x M16	48	M16	12	9
WKL-000109	TASC-3	Tap Adapter met veiligheids koppeling 48 mm x M18	48	M18	14	11
WKL-000110	TASC-3	Tap Adapter met veiligheids koppeling 48 mm x M20	48	M20	16	12
WKL-000111	TASC-3	Tap Adapter met veiligheids koppeling 48 mm x M22/M24	48	M22, M24	18	14.5
WKL-000112	TASC-3	Tap Adapter met veiligheids koppeling 48 mm x M27	48	M27	20	16
WKL-000113	TASC-3	Tap Adapter met veiligheids koppeling 48 mm x M30	48	M30	22	18

RA – Reductie Adapters

Product Code	Type	Omschrijving
RDC-000008	RA 2/1	Reductie Adapter 2/1 (31 mm / 19 mm)
RDC-000009	RA 3/1	Reductie Adapter 3/1 (48 mm / 19 mm)
RDC-000010	RA 3/2	Reductie Adapter 3/2 (48 mm / 31 mm)



PRO-122T TECHNISCHE SPECIFICATIES

Motorsnelheden (onder belasting)	75-110 rpm (1e versnelling) 135-200 rpm (2e versnelling) 220-320 rpm (3e versnelling) 390-570 rpm (4e versnelling)
Vermogen	2300 W
Gewicht	25 kg
Max. Kernboor	120 mm *
Max. Spiraalboor	31.75 mm
Max. tap diameter	M30
Slag	225 mm
Max. snijdiepte	100 mm
Voltage	1- 220-240 V, 50-60 Hz 1- 110-120 V, 50-60 Hz
Beveiliging tegen overbelasting	yes
Beveiliging tegen oververhitting	yes
Continue snelheidsaanpassing	yes
ESSS (Elektronisch Snelheid Stabiliteit Systeem)	yes
Halfautomatische Gib-aanpassing	yes
MFSC (Magnetisch veldvormcontrole)	yes
ESB Energie zuinige basis	yes
Magneet onthechting beveiliging	yes
Magnetische klemkracht (oppervlak met een dikte van 25 mm en ruwheid Ra = 1,25)	1835 kgf (18 000 N)
Afmeting magneetvoet	110 mm x 220 mm x 50 mm
Minimale werkstuk dikte	10 mm
Spindel	MK3
Gereedschap houder	19 mm (3/4") of 32 mm (1-1/4") Weldon
Product Code 220-240 V, 50-60 Hz	WRT-0563-10-20-01-1
Product Code 110-120 V, 50-60 Hz	WRT-0563-10-10-01-1

* Indien meer dan 60 mm, gebruik dan een MT3-as met 32 mm Weldon-gereedschapshouder (UCW-0563-22-00-00-0).

Standaard geleverd:

- Boormachine
- Beschermkoffer
- Handel (3 stuks)
- MK3-as met 19 mm Weldon-gereedschapshouder
- veiligheid sjoband
- Koelsysteem
- Beschermveer voor koelslang
- MK3 uitdrijfspie
- 6 mm zeskantsleutel
- 5 mm zeskantsleutel met handel
- 2.5 mm zeskantsleutel
- Combinatiesleutel 8 mm
- gereedschap opberg bus
- Vergrendelingsconnector (alleen in 115 V-versie)
- Handleiding

Meer optionele toebehoren:

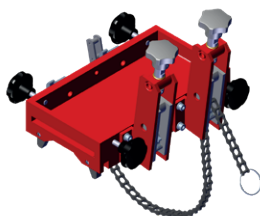

Buisbevestiging DMP 501 voor buizen met een diameter van 150-500 mm (6-20")
product code:
PDS-0111-03-00-01-0



As MT3 x 32 mm Weldon voor boordiameter groter dan 60 mm (2,3")
product code:
UCW-0563-22-00-00-0



Perslucht koelsysteem capaciteit van 2 liter
product code:
UKL-0440-16-00-00-0

Afmetingen:

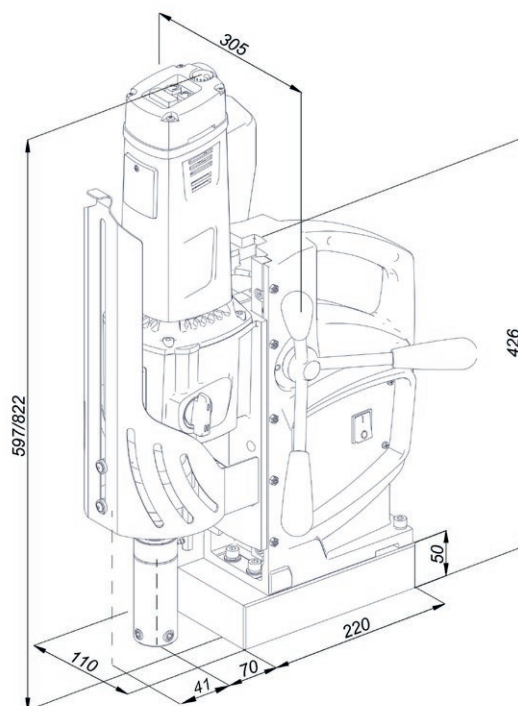

Max. Boordiepte 100 mm

Alle informatie kan zonder voorafgaande kennisgeving worden gewijzigd. 24.09



PROMOTECH Sp. z o.o.
ul. Elewatorska 23/1, 15-620 BIAŁYSTOK, POLAND
tel. (+48 85) 678 34 05, fax (+48 85) 662 78 77
marketing@promotech.eu www.promotech.eu

Uw lokale dealer

