

■ PRO-36 PM Battery | CORDLESS DRILL WITH PERMANENT MAG BASE

This special design battery-operated drilling machine equipped with permanent magnetic base is dedicated to operate in remote areas, where no power supply is available.

The base includes very strong neodymium magnets and does not require any electricity to operate.

PRO-36 PM Battery is equipped with LED monitoring system that generates signals in green and red colors to indicate the current status of the drill and provide safety information.

The drill can be used with convex (min diameter - 80 mm) and concave (min diameter 1000 mm) materials.

■ Features and benefits:

- LED interface flashes green when inadequate adhesion is detected due to e.g. gap or thin work piece
- dual bars guide system ensures extraordinary stiffness and adjustment free operation
- overload protection
- tilt sensor stops the motor if machine breaks away
- control panel is equipped with so called „vandal resistant“ illuminated start/stop motor buttons.

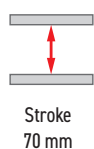
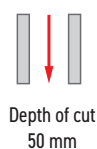

Permanent magnetic base:

- new proprietary permanent magnetic base was designed by Promotech R&D using computer-aided magnetic field analysis together with precise estimation of the magnetic holding force
- the base is equipped with very strong neodymium magnets and does not require any electricity to operate
- holding force switching function allows easy and precise positioning of the drill when the magnetic base is partially engaged

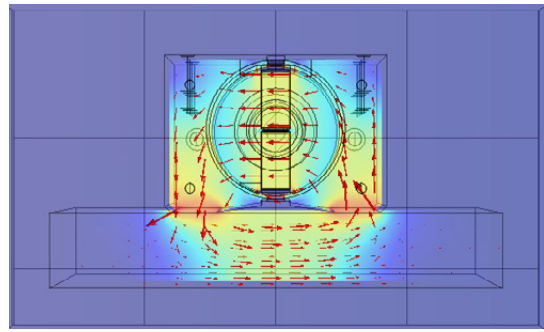

New permanent magnetic base is dedicated to operate with:

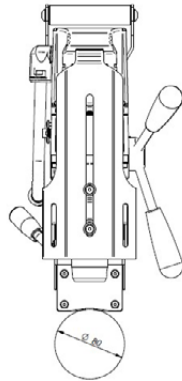

convex (min diameter - 80 mm) materials

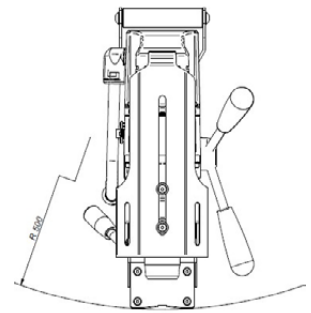
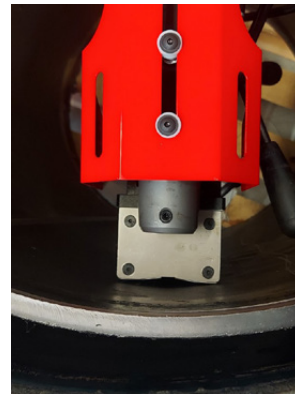

and concave (min diameter 1000 mm) materials



New control system of battery pack:

Detection and supervised parameters:

- too low and too high voltage
- too low and too high temperature
- failure of the temperature sensor
- internal battery failure

Benefits:

- 2-stage over discharge battery protection system
- extended battery life
- high level of safety for both cordless drill and operator



Battery 4.0 Ah



Battery 5.5 Ah









Battery 10.0 Ah

LED Monitoring System

PRO-36PM Battery is equipped with LED monitoring system that generates signals in green and red colors to indicate current condition of the drill and give safety information.

Please pay particular attention that the permanent magnetic base must first be activated. Otherwise it will not be possible to switch on the motor.

 CONDITION OF THE DRILL		Strong surface. Ready to Operate. <i>Solid Green</i>
		Emergency stop (overload, clamping loss). <i>Red Flashes</i>
		Motor doesn't turn on. Replace discharged battery. <i>Solid Red</i>
 SAFETY INFORMATION		Motor doesn't turn on. Switch on the base first. <i>Flashing Green</i>



Sleep mode

When the power is switched on and motor is switched off, the drill enters sleep mode after 60 seconds of inactivity to save the battery. Flashing motor buttons indicate an upcoming sleep mode.



Activated sleep mode:

- Power button in the switched-on position
- Motor buttons off
- LED off



PRO-36 PM Battery Technical Specification	
Motor speed (under load)	260 rpm
Power	400 W
Weight	14.5 kg (with 4.0 Ah battery)
Max milling capacity	36 mm (1.42") with TCT cutters 30 mm (1.18") with HSS cutters
Max drilling capacity	12 mm (0.47")
Stroke	70 mm (2.76")
Max depth of cut	50 mm (1.97")
Voltage	18 V DC
Magnetic base holding force	714 kgf (7 000 N)
Magnetic base dimensions	75 mm × 188 mm × 53 mm
Minimum workpiece thickness	6 mm (0.24")
Tool holder	19 mm (3/4") Weldon
Product Code	WRT-0765-10-00-00-0

Standard shipping set:

- Cordless Drilling Machine with coolant container
- Plastic Box
- Battery 4.0 Ah
- Handle (3 pcs)
- Safety strap
- Allen wrench hex s=4 with handle
- Operator's Manual

Selected additional accessories:

- AKM-0738-10-00-01-0 Battery 4.0 Ah
- AKM-0738-10-00-03-0 Battery 5.5 Ah
- AKM-0738-10-00-02-0 Battery 10 Ah
- LDW-0738-10-00-30-0 Battery charger ASC 145 (EU)
- LDW-0738-04-00-30-0 Battery charger ASC 145 (UK)
- LDW-0738-06-00-30-0 Battery charger ASC 145 (AUS/NZ)
- UKL-0440-16-00-00-0 Pressure cooling system
- PDS-0587-10-00-00-0 Vacuum pad
- AGR-0541-10-20-00-0 Vacuum pump (230 V CEE)
- AGR-0541-10-10-00-0 Vacuum pump (115 V UK)
- ZSP-0587-11-00-00-0 Compressed air ejector

Dimensions:

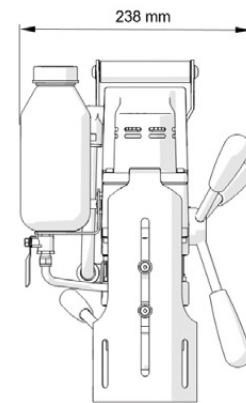
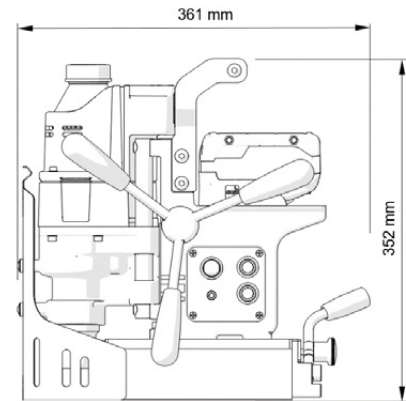

Ergonomic handle for easy transportation



Battery 4.0 Ah

Battery 5.5 Ah

Battery 10.0 Ah



Battery charger

Charging time
~ 30 min (4.0 Ah)
~ 41 min (5.5 Ah)
~ 74 min (10.0 Ah)



Vacuum pad



Compressed air ejector



Pressure cooling system



Vacuum pump



PROMOTECH Sp. z o.o.
ul. Elewatorska 23/1, 15-620 BIAŁYSTOK, POLAND
tel. (+48 85) 678 34 05, fax (+48 85) 662 78 77
marketing@promotech.eu www.promotech.eu

Your local dealer:

