

## ■ BM-18 | MULTITASK PLATE AND PIPE BEVELLER

The BM-18 is a new generation portable multitask plate and pipe beveler driven by a powerful electric motor.

It enables milling straight edges up to 18 mm bevel width, contours, holes from 40 mm in diameter and rounding off steel construction before painting or coating with radius R2, R3, R4 or R5.

New hexagonal fixing of milling heads increases beveler durability and makes replacement of the heads more convenient and user-friendly.

Variable spindle speed enables optimizing cutting conditions depending on sort of material grade incl. stainless steel, alloys, aluminum, brass or plastic.



### ■ Features & benefits:

- Powerful electric motor
- Maximum 18 mm bevel width (more than one pass could be required)
- Continuous bevel width adjustment
- New more durable milling heads with hexagonal fixing for easy replacement
- Electronic speed control between 1800–5850 rpm for use on a variety of materials
- Overload protection
- Beveling milling head is equipped with 5 pcs of 2-sided indexable cutting inserts
- Milling head for rounding is equipped with 4 pcs of 4-sided indexable inserts up to R5

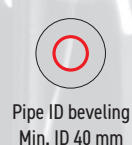
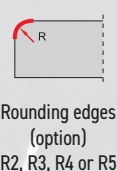
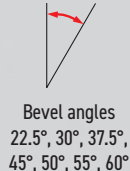

## New design of milling heads with hexagonal fixing

- increases durability
- more convenient assembly and disassembly of the milling head
- guiding roller is integrated with each milling head
- the clearance between milling head and guiding roller is precisely factory calibrated, thus requires no adjustment by the operator



Beveling milling head

Milling head for rounding

Accessories:	
GLW-0640-30-01-00-0	Beveling milling head 22.5° (5 cutting inserts required)
GLW-0640-30-02-00-0	Beveling milling head 30° (5 cutting inserts required)
GLW-0640-30-03-00-0	Beveling milling head 37.5° (5 cutting inserts required)
GLW-0640-30-04-00-0	Beveling milling head 45° (5 cutting inserts required)
GLW-0640-30-05-00-0	Beveling milling head 50° (5 cutting inserts required)
GLW-0640-30-06-00-0	Beveling milling head 55° (5 cutting inserts required)
GLW-0640-30-07-00-0	Beveling milling head 60° (5 cutting inserts required)
PLY-000395	Cutting insert for steel (sold 10 pcs/box)
PLY-000195	Cutting insert for aluminum (sold 10 pcs/box)
GLW-0640-30-34-00-0	Milling head for rounding (4 cutting inserts required)
PLY-000737	Cutting insert R2 (sold 10 pcs/box)
PLY-000738	Cutting insert R3 (sold 10 pcs/box)
PLY-000739	Cutting insert R4 (sold 10 pcs/box)
PLY-000740	Cutting insert R5 (sold 10 pcs/box)



Spare and consumable parts:	
SRB-000289	Insert Screw (Radius)
SRB-000290	Insert Screw (Beveling)
SMR-000005	Screw grease (5 g)
RLK-0640-99-02-00-0	Beveling roller
RLK-0640-99-03-00-0	Radius roller
SCZ-000031	Carbon brush for 110 V
SCZ-000030	Carbon brush for 230 V
NKL-0509-05-00-00-0	Sticker against scratches (for aluminum beveling)



Cutting insert for steel



Insert Screw (Beveling)



Cutting inserts for aluminum

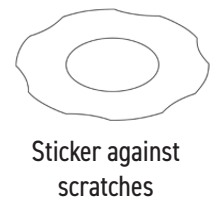

Sticker against scratches



Cutting insert R2



Cutting insert R3

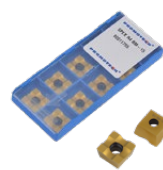

Cutting insert R4



Cutting insert R5



Insert Screw (Radius)

## Radius insert positioner for BM-18

Useful device for easy and precise setting of radius R2, R3, R4 and R5.

Product code: UST-0509-16-00-00-0

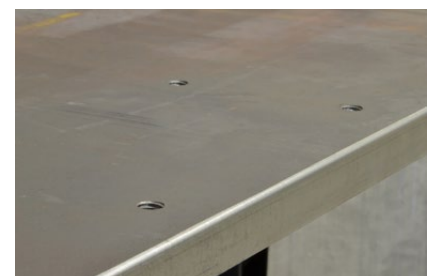
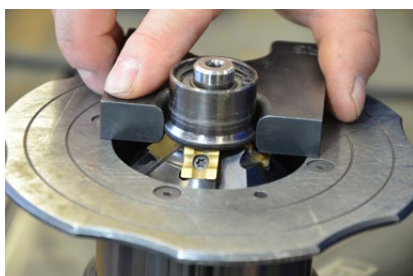



## ■ Pipe attachment for BM-18

Allows external beveling of pipes with a diameter of at least 150 mm (5.9") and internal beveling of pipes with a diameter of at least 110 mm (4.3").

Product code: PRW-0509-07-00-00-0



## ■ Worktable fixture for BM-18

Handy and convenient tool for machining small workpieces with cross section of at least 15×25 mm (0.6×1") and length of at least 400 mm (16").

The width of the workpiece can be up to 100 mm (4"), and height up to 65 mm (2.5"). The maximum bevel width is 14 mm (0.55").

Product Code: ZBD-0509-12-00-00-0

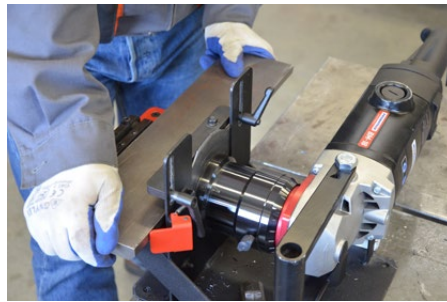
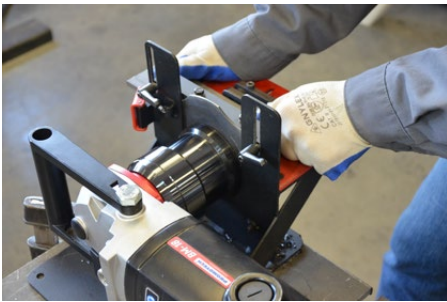

## ■ HD-CUT eco-friendly cooling/lubricating products

Non-corrosive with excellent rust protection, biodegradable coolants offer superior cooling properties and produce outstanding tool life and cut finish.

HD-CUT OIL 1 - tapping, drilling and machining fluid

product codes:

OLJ-0505-09-00-00-0 (0.5 kg)

OLJ-0505-10-00-00-0 (1.0 kg)

OLJ-0505-11-00-00-0 (5.0 kg)



HD-CUT BIO - concentrated micro emulsion for various machining applications

product code:

CHL-0440-42-00-00-0



HD-CLEAN SPRAY multi-purpose industrial degreaser

product code:

ZMY-0440-40-00-00-0



HD-CUT Spray - tapping, drilling and machining multi-position spray

product code:

PRE-0440-41-00-00-0



BM-18 TECHNICAL SPECIFICATION	
Power supply	1~ 220-240 V, 50-60 Hz 1~ 110-120 V, 50-60 Hz
Power	2200 W
Spindle speed (without load)	1800-5850 rpm
Maximum bevel width	b=18 mm (0.71", Fig. 1)
Bevel angle (depending on milling head)	$\beta = 22.5^\circ, 30^\circ, 37.5^\circ, 45^\circ, 50^\circ, 55^\circ, 60^\circ$ (Fig. 1)
Minimum workpiece thickness	2 mm (0.08")
Minimal diameter of countersinking	ca 40 mm (1.57")
Rounding edges	R2, R3, R4, R5 (Fig. 2)
Dimensions (L x W x H)	585 mm (23.0") x 156 mm (6.1") x 238 mm (9.4")
Weight (without milling head)	10 kg (22 lbs)
Product code 220-240 V, 50-60 Hz	UKS-0670-10-20-00-0
Product code 110-120 V, 50-60 Hz	UKS-0670-10-10-00-0

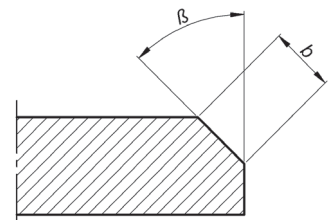

Fig. 1

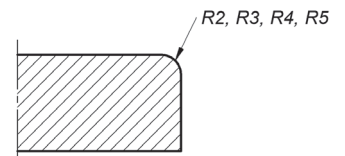
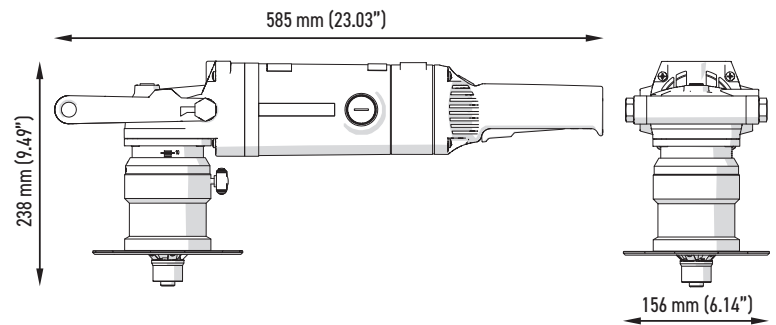

Fig. 2



### Basic set:

- BM-18 beveling machine without accessories
- Plastic box
- 32mm flat wrench
- Allen wrench hex s=6
- Grease for screws (5 g, 0.17 oz)
- Operator's Manual (English)



Aluminum beveling



Countersinking



Rounding off curved edges



Pipe beveling



Machining small workpieces



Lightweight and durable plastic box for convenient storage and transportation

All information is subject to change without notice. 21.10



PROMOTECH Sp. z o.o.  
ul. Elewatorska 23/1, 15-620 BIAŁYSTOK, POLAND  
tel. (+48 85) 678 34 05, fax (+48 85) 662 78 77  
marketing@promotech.eu www.promotech.eu

Your local dealer:

