

PRO-60 HP | PORTABLE HYDRAULIC PUNCHERS

PRO-110 HP



Primary features and benefits:

- Double action - fully automated process of punching and return
- Wide range of hole diameters up to 27 mm
- Modern construction
- Intelligent control system with inching and automatic load detection
- Mode indicator light
- Protection against accidental start-up
- Easy to handle in out-of-normal positions
- All connecting ports located at the back
- Wide range of special-shaped punches and dies
- Patent pending compact moveable hydraulic power pack
- Unique Gantry Punching Station increases both productivity and operator's comfort

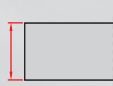

max. thickness



max. throat depth



max. hole



max. oblong hole



punching time



punching power



double action hydraulic movement

PRO-60 HP	13 mm	60 mm	27 mm	25 x 18 mm	5 sec	35 ton	YES
PRO-110 HP	16 mm	110 mm	27 mm	25 x 18 mm	8 sec	47 ton	YES

Portable Double-Action Hydraulic Puncher Technical Specification	model PRO-60 HP	model PRO-110 HP
Max. throat depth	60 mm	110 mm
Max. hole	Ø 27 mm	Ø 27 mm
Max. oblong hole	25 x 18 mm	25 x 18 mm
Punching time	5 sec	8 sec
Max. plate thickness	13 mm	16 mm
Punching power	35 ton	47 ton
Working pressure	700 bar	700 bar
Weight	20 kg	35 kg
Product code	GLW-0522-10-00-00-1	GLW-0507-10-00-00-0



Ready to work in both vertical and horizontal positions

Double-Action Hydraulic Power Pack model HPP 700/1.5	
Power supply*	230V/50Hz; 115V/60Hz
Power	2000 W
Working pressure	700 bar
Pump output	1.5 L/min
Oil capacity	10 L
Product code	ZSL-0517-10-20-00-0 HPP-700/1,5 / 220-240V/50Hz

* Contact Promotech for other voltage options



Portable hydraulic power pack with shelf for puncher transport.



Dimensions

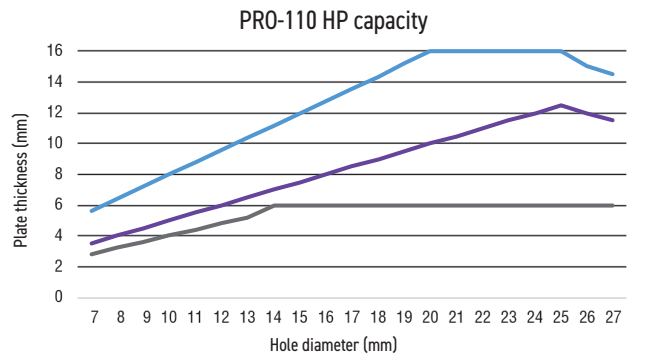
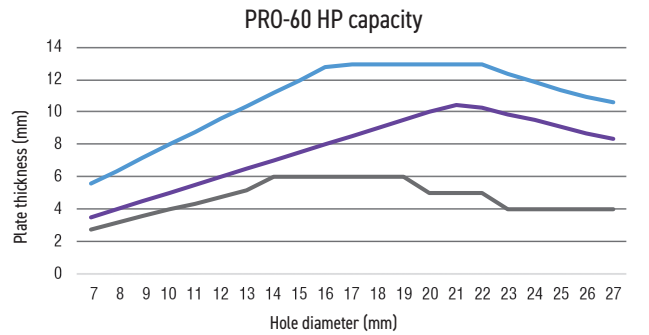
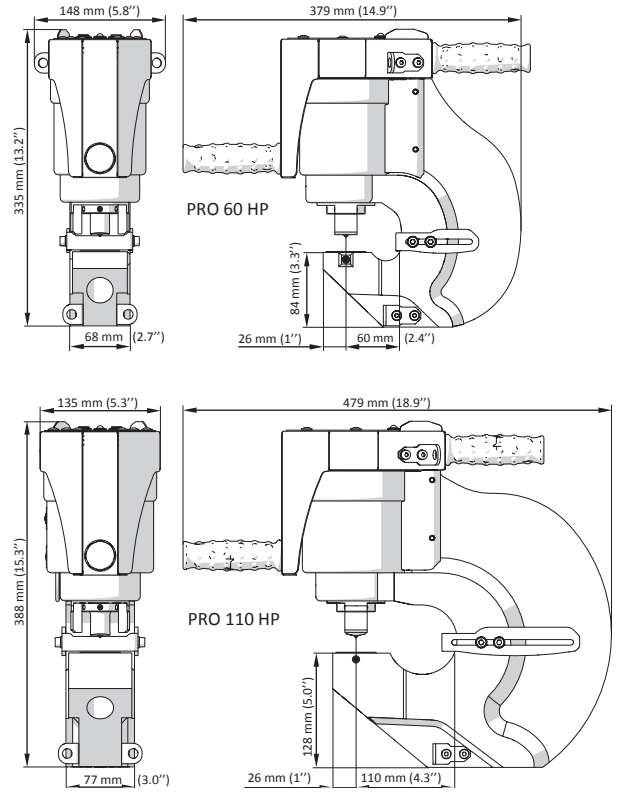

— Rm < 490 MPa — Rm = 490-630 MPa — Rm = 630-750 MPa



Balancer for PRO-60 HP; Product code: BLN-000004
Balancer for PRO-110 HP; Product code: BLN-000005

Customize your work place with a variety of optional accessories.

Hoist set

Product code: ZUR-0517-15-00-00-0



Simple set-up and easy adjustment of height and balance control.

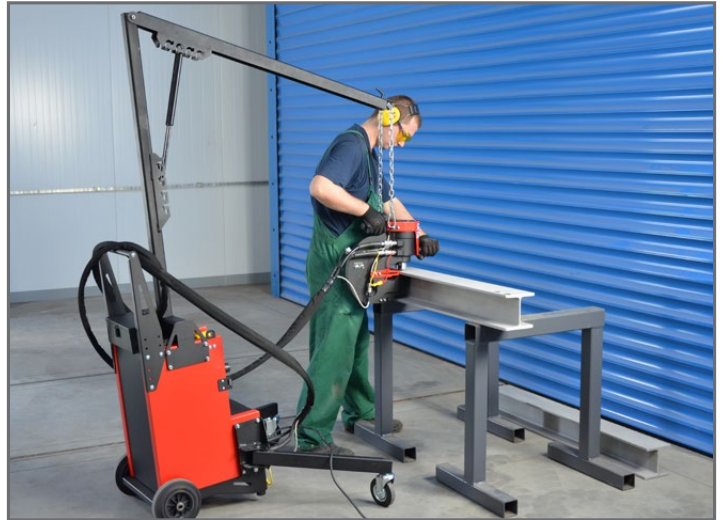

Hoist arm and 2 supports with wheels allow for easy manipulation of punch and power pack as single unit.

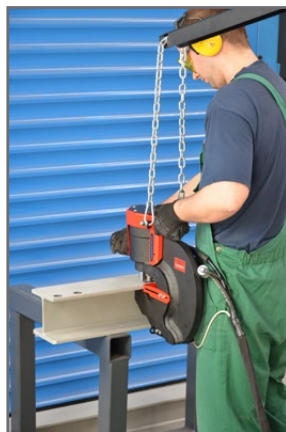

Unique solution which makes your work as efficient and comfortable as never before.

Wheel puncher slide

Product code: PRW-0507-90-00-00-0

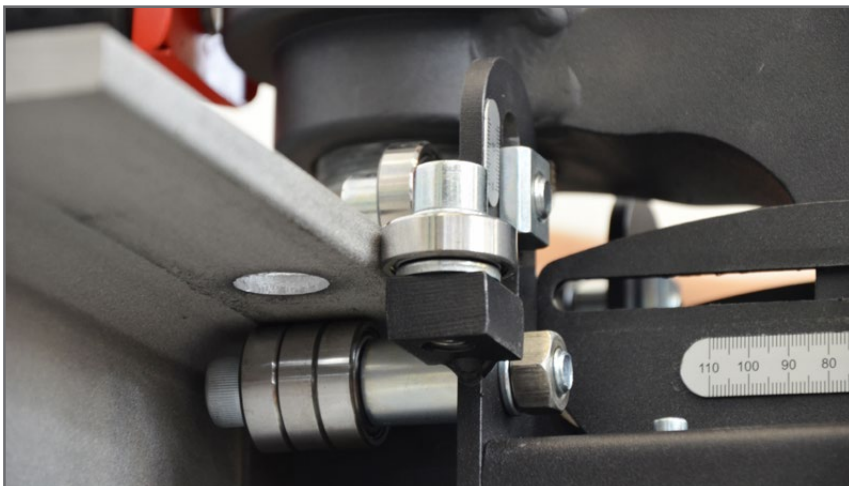

Permits smooth and efficient lineal movement along the workpiece.



Bench top stand with foot pedal

Product code: ZST-0507-91-00-00-0



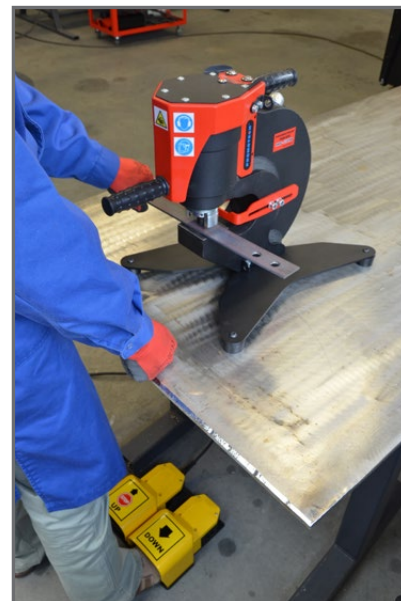

Neither balancer nor hoist arm is required to keep puncher in place.
An operator can use start and stop bottoms on the machine or foot pedals.





Foot pedal machine control in hands free operation on bench top configuration.

Punches & dies

Hydraulic Punchers tools		
Oblong [mm]	Punch - product code	Die - product code
16x8	STM-0507-30-13-00-0	MTY-0507-70-13-00-0
18x9	STM-0507-30-12-00-0	MTY-0507-70-12-00-0
18x11	STM-0507-30-11-00-0	MTY-0507-70-11-00-0
20x10	STM-0507-30-10-00-0	MTY-0507-70-10-00-0
20x12	STM-0507-30-09-00-0	MTY-0507-70-09-00-0
20x14	STM-0507-30-08-00-0	MTY-0507-70-08-00-0
22x11	STM-0507-30-07-00-0	MTY-0507-70-07-00-0
22x14	STM-0507-30-06-00-0	MTY-0507-70-06-00-0
24x12	STM-0507-30-05-00-0	MTY-0507-70-05-00-0
25x9	STM-0507-30-04-00-0	MTY-0507-70-04-00-0
25x12	STM-0507-30-03-00-0	MTY-0507-70-03-00-0
25x13	STM-0507-30-02-00-0	MTY-0507-70-02-00-0
25x14	STM-0507-30-01-00-0	MTY-0507-70-01-00-0
25x16	STM-0507-30-17-00-0	MTY-0507-70-17-00-0
25x18	STM-0507-30-00-00-0	MTY-0507-70-00-00-0

Various hydraulic punch tools are available on request in imperial or metric sizes.

Hydraulic Punchers tools			
Diameter [mm]	Punch - product code	Die - product code	Die 5° - product code
7	STM-0507-20-18-00-0	MTY-0507-40-18-00-0	-
8	STM-0507-20-17-00-0	MTY-0507-40-17-00-0	-
9	STM-0507-20-16-00-0	MTY-0507-40-16-00-0	MTY-0507-50-16-00-0
10	STM-0507-20-15-00-0	MTY-0507-40-15-00-0	MTY-0507-50-15-00-0
11	STM-0507-20-14-00-0	MTY-0507-40-14-00-0	MTY-0507-50-14-00-0
12	STM-0507-20-13-00-0	MTY-0507-40-13-00-0	MTY-0507-50-13-00-0
13	STM-0507-20-12-00-0	MTY-0507-40-12-00-0	MTY-0507-50-12-00-0
14	STM-0507-20-11-00-0	MTY-0507-40-11-00-0	MTY-0507-50-11-00-0
15	STM-0507-20-10-00-0	MTY-0507-40-10-00-0	MTY-0507-50-10-00-0
16	STM-0507-20-09-00-0	MTY-0507-40-09-00-0	MTY-0507-50-09-00-0
17	STM-0507-20-08-00-0	MTY-0507-40-08-00-0	MTY-0507-50-08-00-0
18	STM-0507-20-07-00-0	MTY-0507-40-07-00-0	MTY-0507-50-07-00-0
19	STM-0507-20-06-00-0	MTY-0507-40-06-00-0	MTY-0507-50-06-00-0
20	STM-0507-20-05-00-0	MTY-0507-40-05-00-0	MTY-0507-50-05-00-0
21	STM-0507-20-04-00-0	MTY-0507-40-04-00-0	MTY-0507-50-04-00-0
22	STM-0507-20-03-00-0	MTY-0507-40-03-00-0	MTY-0507-50-03-00-0
23	STM-0507-20-02-00-0	MTY-0507-40-02-00-0	MTY-0507-50-02-00-0
24	STM-0507-20-01-00-0	MTY-0507-40-01-00-0	MTY-0507-50-01-00-0
25	STM-0507-20-00-00-0	MTY-0507-40-00-00-0	MTY-0507-50-00-00-0
26	STM-0507-20-19-00-0	MTY-0507-40-19-00-0	MTY-0507-50-19-00-0
27	STM-0507-20-20-00-0	MTY-0507-40-20-00-0	MTY-0507-50-20-00-0

All information is subject to change without notice. 21.12



PROMOTECH Sp. z o.o.
ul. Elewatorska 23/1, 15-620 BIAŁYSTOK, POLAND
tel. (+48 85) 678 34 05, fax (+48 85) 662 78 77
marketing@promotech.eu www.promotech.eu

Your local dealer:

