

## PRO-16 | 2-SPEED DRILLING MACHINE

PRO-16 featuring purpose designed motor and 2-speed gear box 390/780 rpm is optimized to provide appropriate speed for work with cylindrical twist drills up to  $\Phi$  16 mm. Rigid construction, optimized by means of FEA (finite element analysis) software extends tool life. Compact design along with innovative smart magnet with reduced weight make it a lightweight machine.

PRO-16 provides maximum holding power on thin materials thanks to Magnetic Field Shape Control (MFSC). The drill protects both the machine and the operator from work on too thin workpiece by means of Magnetic Power Adhesion Control (MPAC).

PRO-16 is also equipped with Energy Saving Base (ESB) that uses only 50% of its power when motor is not running.

### Features and benefits:

- Compact design with excellent ratio weight/power
- Purpose designed motor
- Motor Speeds 390/780 rpm (under load)
- Spindle equipped with  $\frac{1}{2}$ " tread
- Innovative smart magnet with reduced weight
- Rigid design to extend tool life
- Large stroke enables the use of long tools
- Motor cable with additional protective cover
- Magnetic Field Shape Control (MFSC) provides maximum holding power on thin materials
- Magnetic Power Adhesion Control (MPAC) detects adhesive force of electromagnetic base and protects both the machine and the operator from work on too thin workpiece
- Energy Saving Base (ESB) uses only 50% of its power when motor is not running

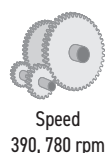
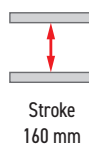
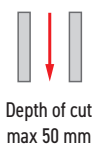
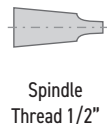
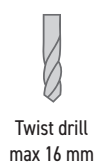

## ■ New mid-range drill family at your service

Promotech is introducing new family of drills that are designed for maximum milling/drilling performance.

Customers can choose from 6 models with various tool holders including:

- Thread 1/2"
- Weldon 19,05 mm (3/4")
- Morse Taper #2.

These new drills are optimized for work with HSS cutters, TCT cutters or twist drills.



## ■ Best practices and new ideas

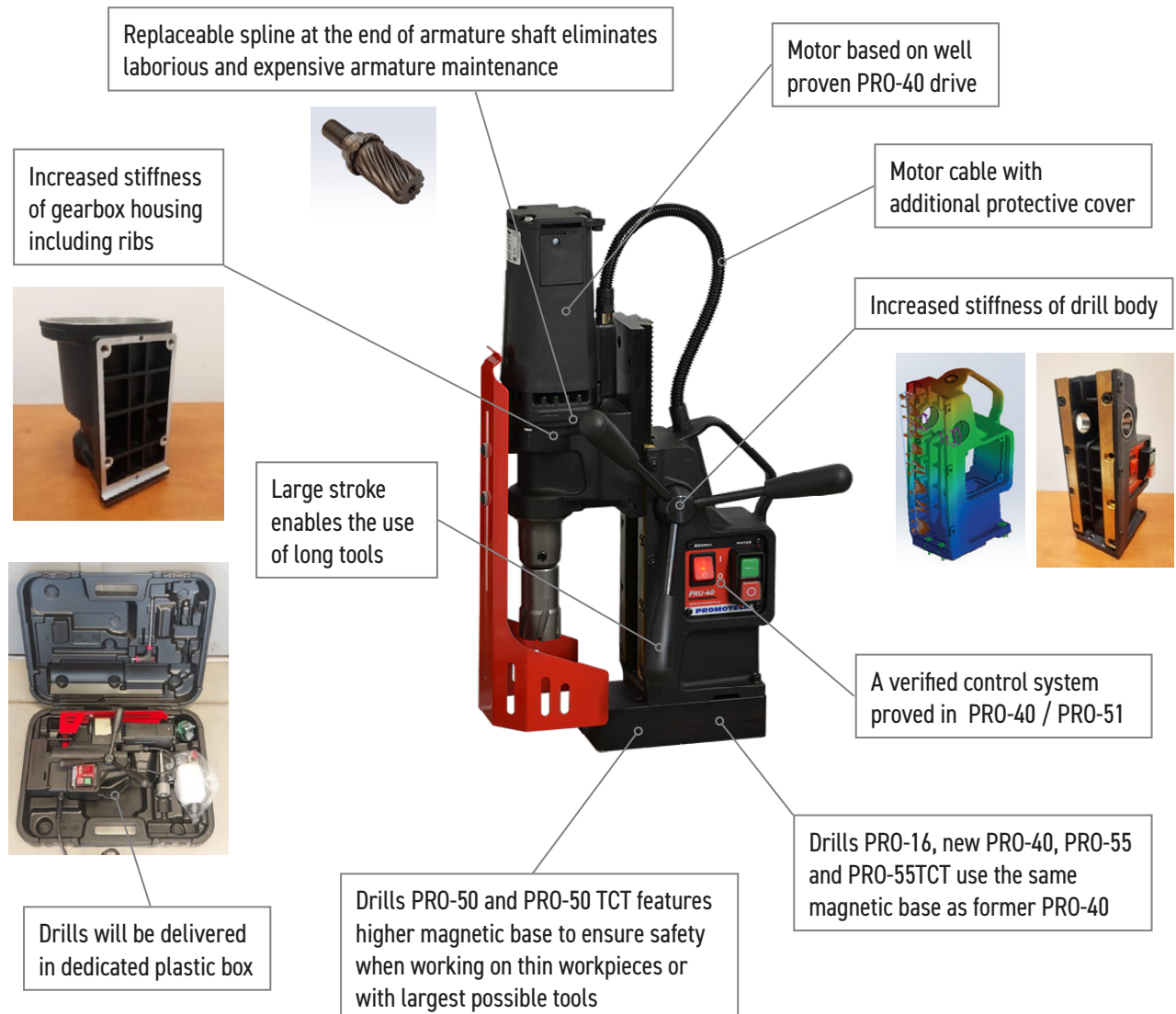



**Increased productivity and extended tool life**

The right choice of drilling machine for a specific application can increase process productivity and extend tool life, especially when drilling a large number of holes of the same size.

The design of the new drills is based on well proven electric motor successfully used for many years in the PRO-40 drilling machines.

Most of the components are common between the new models, which allows for flexibility in production, shorter delivery times and immediate response to market demand for specific versions of new drills.

All drills are equipped with smart electromagnetic bases including many advanced systems.

Magnetic power adhesion control module (MPAC) detects adhesive force and protects both the machine and the operator from work on too thin work pieces.

Magnetic field shape control system (MFSC) provides maximum holding power on thin materials.

Energy Saving Base (ESB) uses only 50% of its power when motor is not running.

Compact design allows the operator to drill very close to side wall and corners.



Drilling capacity up to 16 mm (0.63")  
 - with cylindrical shank twist drill in use  
 Drilling capacity up to 23 mm (0.91")  
 - with MT2 shank twist drill in use



Out of position drilling



Milling capacity up to 55 mm (2.17")  
 Depth of cut up to 75 mm (3")



Starting point of milling up to 50 mm (2")  
 below a level of a drill base

**Features and benefits of new mid-range drill family:**

- Wide selection of 6 models tailored to certain drilling applications
- Purpose designed motor proven for many years in the PRO-40 drill
- Heavy duty gear boxes optimized to match the appropriate speed of specific tools in use
- Innovative smart magnet with reduced weight
- Compact design with excellent ratio weight / power
- Various tool holders
- Rigid design to extend tool life
- Magnetic Field Shape Control (MFSC)
- Magnetic Power Adhesion Control (MPAC)
- Energy Saving Base (ESB)

**Possible tool configurations of PRO-16**



Adapter 3/4" x 1/2" 20 UNF, Drilling chuck 1/2" 20 UNF  
 Twist drills up  $\Phi$  11.8 mm (DIN 338)



Adapter 3/4" x 1/2" 20 UNF, Drilling chuck 1/2" 20 UNF  
 Twist drills up to  $\Phi$  16.0 mm (DIN 1897)



**PRO-16 TECHNICAL SPECIFICATION**

Motor Speeds (under load)	390/780 rpm
Power	1100 W
Weight	14 kg (31 lbs)
Max milling capacity TCT/HSS	-
Max drilling capacity	16 mm (0.63")
Stroke	160 mm (6.3")
Max depth of cut	50 mm (2")
Voltage	1~ 220-240 V, 50-60 Hz 1~ 110-120 V, 50-60 Hz
MFSC (Magnetic Field Shape Control)	yes
MPAC (Magnetic Power Adhesion Control)	yes
ESB (Energy Saving Base)	yes
Magnetic clamping force (surface with the thickness of 25 mm and roughness Ra = 1.25)	1009 kgf (9900 N)
Magnet base dimensions	84 × 168 × 41.5 (mm) 3.3 × 6.6 × 1.6 (")
Min. work piece thickness	6 mm (1/4")
Spindle	Thread 1/2"
Tool holder	as spindle
Product Code 220-240 V, 50-60 Hz	WRT-0740-10-20-00-0
Product Code 110-120 V, 50-60 Hz	WRT-0740-10-10-00-0

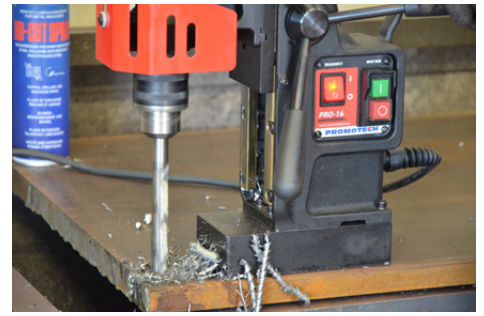

Drilling capacity up to 16 mm (0.63")



Out of position drilling

**Standard shipping set:**

- Drilling machine
- Plastic box
- Handle (3pcs)
- Safety strap
- Cooling system
- 2.5 mm hex wrench
- 5 mm hex wrench
- 8 mm combination wrench
- Operator's manual

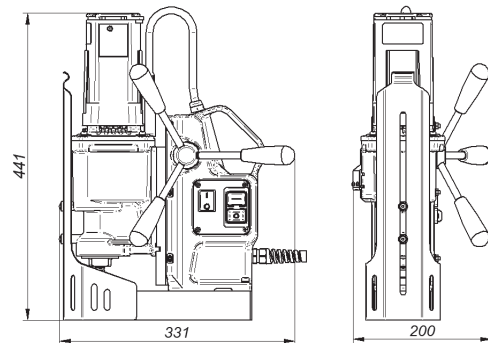

**Selected additional accessories:**

- PDS-0110-03-00-01-0 Pipe attachment DMP 251 for pipes with diameters of 80-250 mm (3-10")
- PDS-0111-03-00-01-0 Pipe attachment DMP 501 for pipes with diameters of 150-500 mm (6-20")
- UKL-0440-16-00-00-0 Pressure cooling system
- UCW-000059 Drilling chuck 1/2" 20 UNF x 1.5-13 mm
- UCW-000061 Drilling chuck 1/2" 20 UNF x 3-16 mm
- PDS-0587-10-00-00-0 Vacuum pad
- AGR-0541-10-20-00-0 (230 V CEE) Vacuum pump
- AGR-0541-10-10-00-0 (115 V UK) Vacuum pump
- ZSP-0587-11-00-00-0 Compressed air ejector



Pipe attachment DMP 251



Pipe attachment DMP 501



Drilling chuck



Pressure cooling system



Vacuum pad



Vacuum pump



Compressed air ejector



PROMOTECH Sp. z o.o.  
ul. Elewatorska 23/1, 15-620 BIAŁYSTOK, POLAND  
tel. (+48 85) 678 34 05, fax (+48 85) 662 78 77  
marketing@promotech.eu www.promotech.eu

Your local dealer:

